

Width of Thread 2.2mm  
Pitch 3.4mm

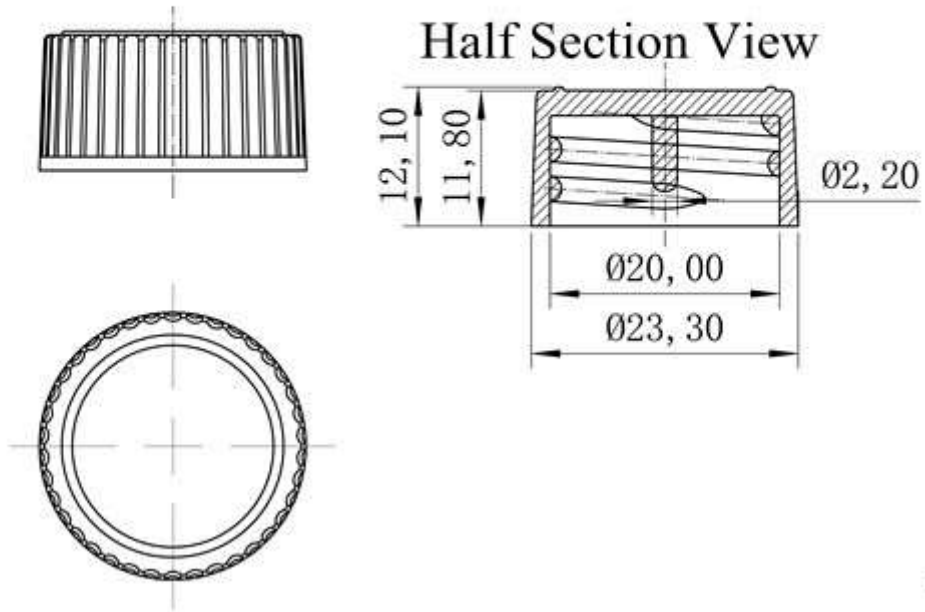

20MM P/P Cap with Cone Liner

Scale:2:1