

CGAB1-60MLM -XXXX
Drawing CG-AB-M60
Revision date:11-May-2022

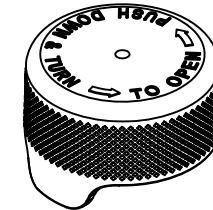

Material: PP

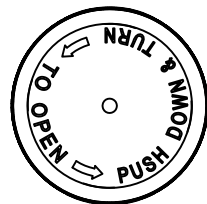
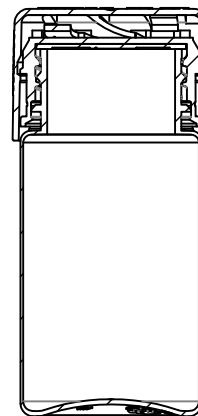
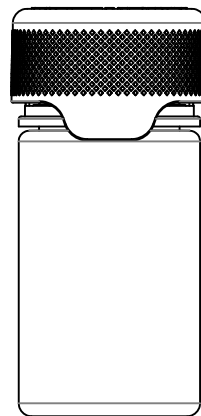
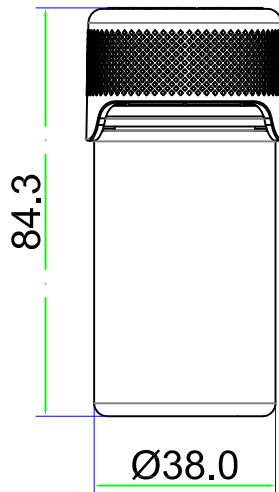
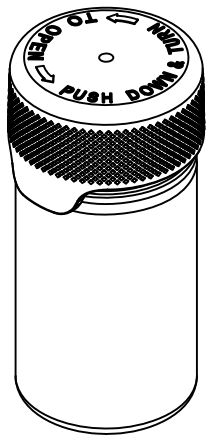
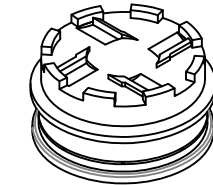

Material: PE



Material: TPE

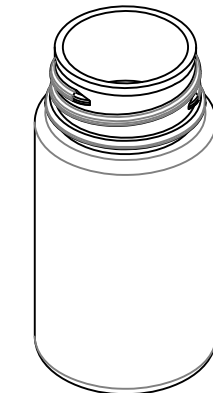

Material: PET

Notes:
1.All dimensions = mm
2.Dimensions=averages
3.Finish size=T32

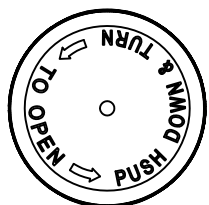
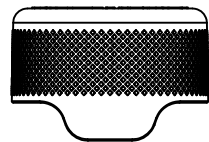
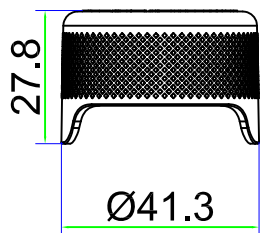
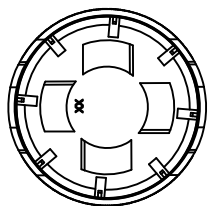

Outer Closure

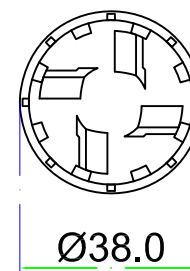
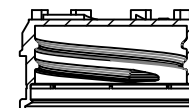
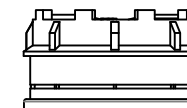
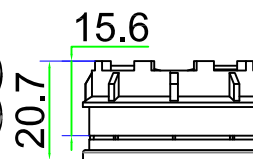
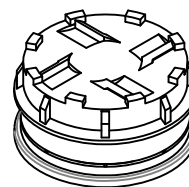
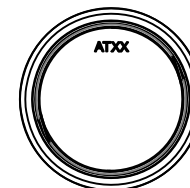

Inner Closure
Page 2 of 3

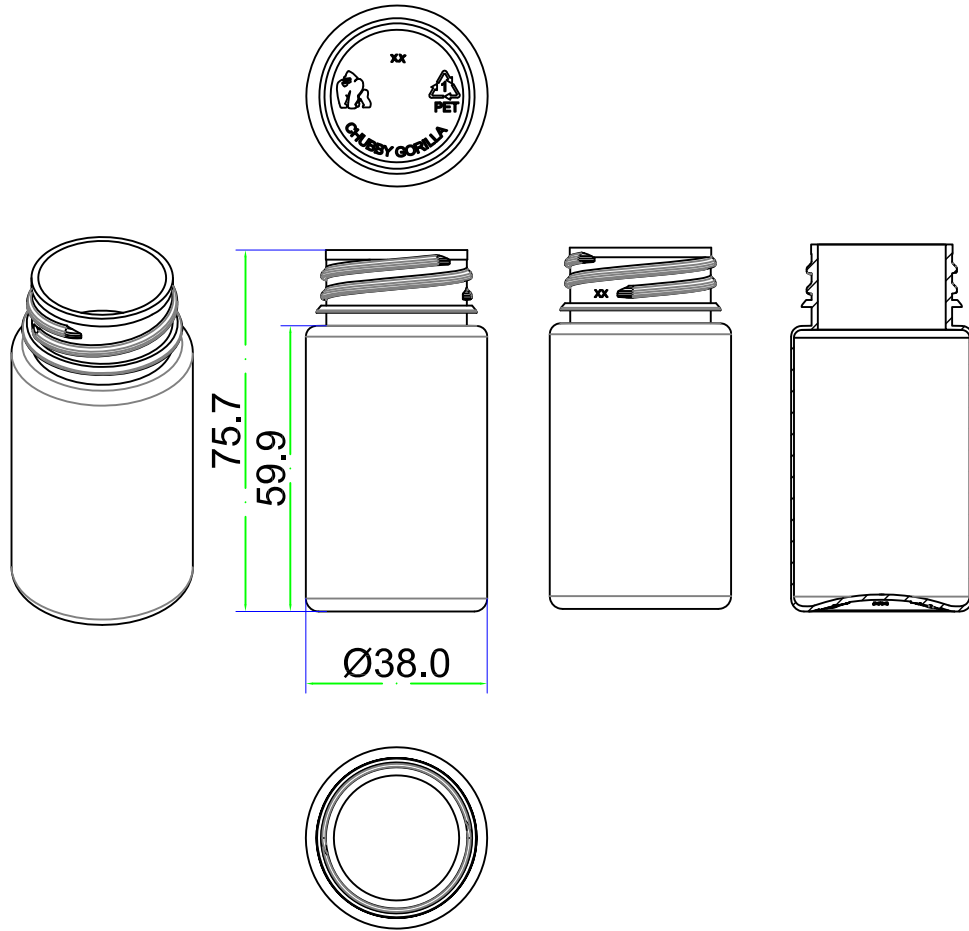

Container

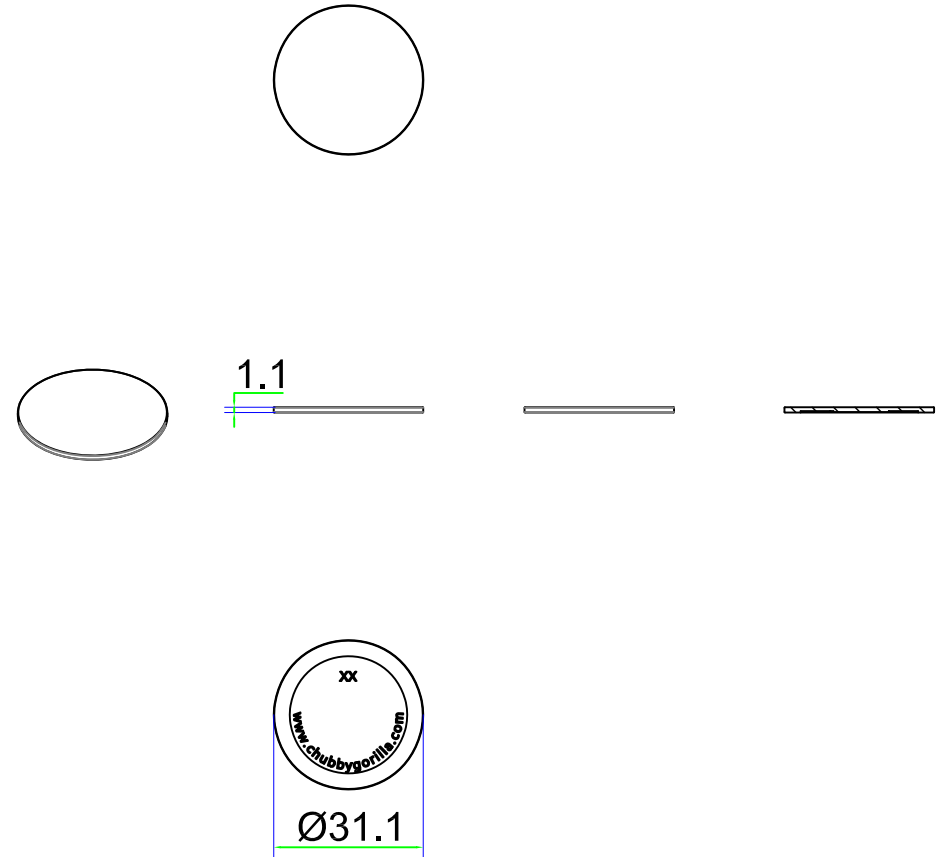

Inner-Seal
Page 3 of 3